

Jumbo

Dimension	110 x 110 / 91 x 91 mm
Stroke	500 mm
Column height	645 mm
Max. load	80 kg, equally divided
Speed, 0-80 kg load	33 mm/sec
Duty cycle	10%, max 1 min. run/9 min. stop
Ambient temperature	0 - 45 C°
Storage & transport temp.	(20) - 70 C°
Friction-control	100%
Motor-brake	Patented by TiMOTION
Motorhouse (L x W x H)	183 x 105 x 50,5 mm
Wiper	Optional colors
Invisible inlay	Optional



12 standard colors

Please request for separate color chart

Jumbo



CE mark - EN standards / tests

The column is CE-marked for a partly completed machinery, according to following directives (Documentations / Technical Dossier upon request):

The machinery directive 2006/42/EC

The EMC directive 2004/108/EC

The LVD directive 2006/95/EC

RoHS compliant, according to directive 2011/65/

EU & REACH compliant, according to directive EC 1907/2006

Other standards / tests

EN ISO 2409:2007





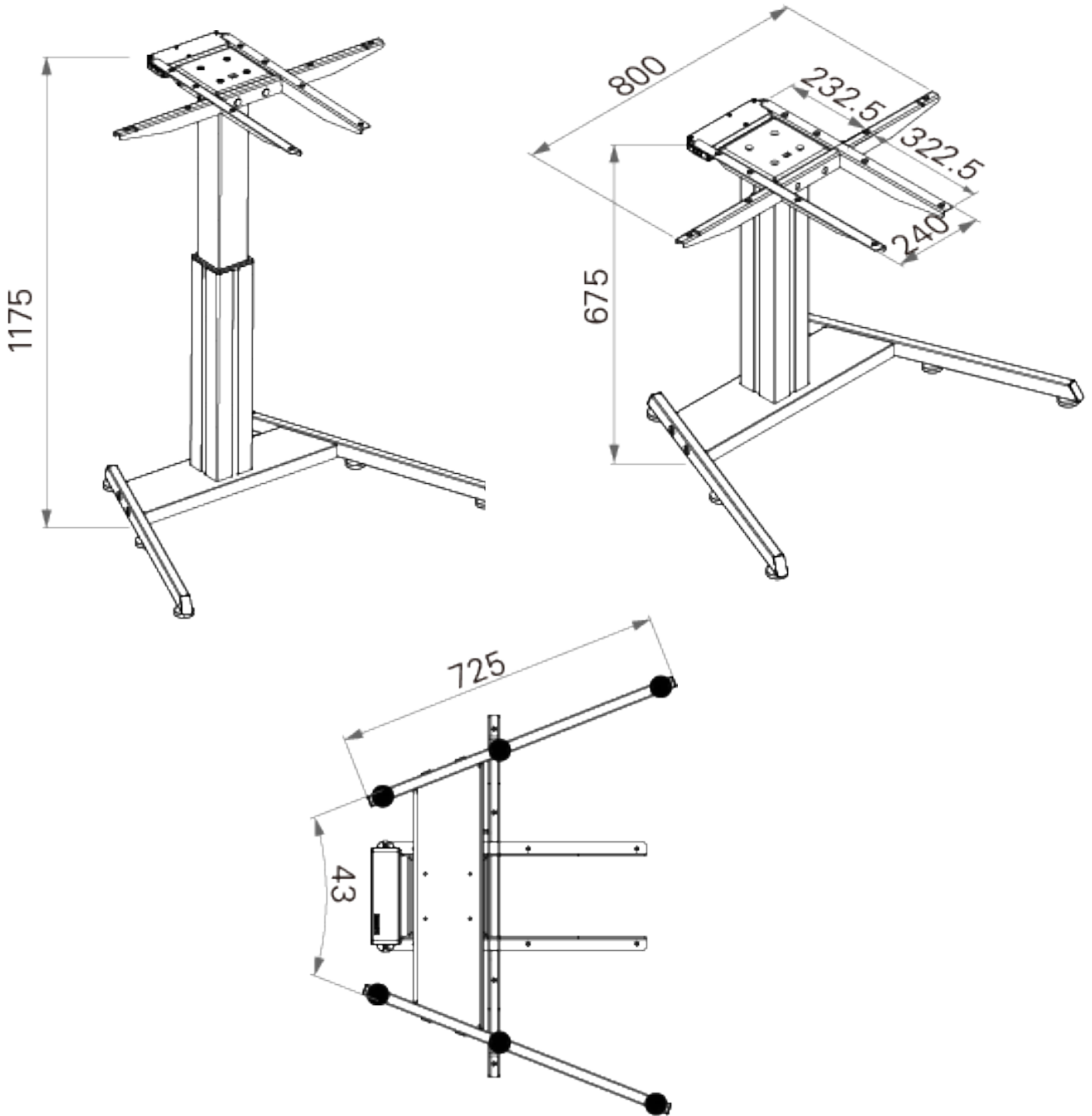

EN 13849

Drawing – Jumbo

Standard dimension (mm)



Marking on labels

	CE mark
	General warning sign https://www.iso.org/obp/ui/#iso:grs:7000:4:0434A
	Class II – double insulation https://en.wikipedia.org/wiki/Appliance_classes
	Indoor use
	WEEE http://en.wikipedia.org/wiki/Waste_Electrical_and_Electronic_Equipment_Directive The electrical device can't be randomly discarded
	Type Approved safety regular production surveillance, which means that the product is ready for GS mark